

Dear customer,

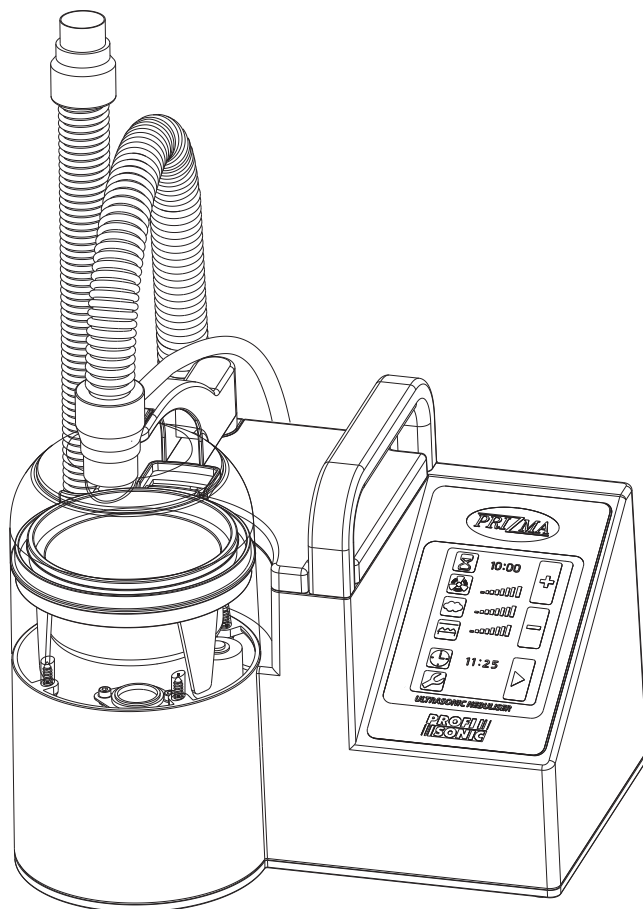

Thank you for purchasing this PRIZMA ultrasonic nebuliser. Please read this instruction manual carefully before using the unit as it contains important health and safety information. Please keep your instruction manual at hand all the time.

This unit is medical instrument. Be sure to use unit properly according to instructions given by medical professionals. Only use medications as prescribed and instructed by your doctor.

We wish you good health and all the best in the future.

*With best regards,  
PRIZMA, Kragujevac*

**IMPORTANT INFORMATION – READ THOROUGHLY**

History of document revisions .....	3
Intended use .....	4
Exclusions and limitations of liability .....	5
Safety notes .....	6

**PRODUCT DESCRIPTION**

Components of the product .....	10
Principle of nebulisation .....	12
Main features of the product .....	12

**USE OF NEBULISER**

How to prepare before inhalation .....	13
How to inhale .....	16
Finishing the inhalation treatment.....	20

**PRODUCT CARE & MAINTENANCE**

How to take care of the nebuliser unit .....	21
Cleaning and disinfection .....	22

**SPECIFICATIONS**

Troubleshooting .....	25
Technical data .....	26
Important information regarding Electro Magnetic Compatibility (EMC) .....	27
Correct disposal of this product (Waste electrical & electronic equipment) .....	27
Optional parts .....	28

## History of document revisions

<i>Version</i>	<i>Date</i>	<i>Description of changes</i>
1.0	01. 02. 2014.	Initial version
1.1	25. 12. 2014.	Package contents
1.2	01. 12. 2015.	Optional parts

## Intended use

PROFI SONIC H is medical device intended for successful treatment of asthma, bronchitis, allergy and other respiratory disorders. Use it only according to recommendations issued by your doctor or therapist.

<b>Intended use</b>	Device is intended to be used for inhalation of medication for respiratory disorders. This device is NOT intended for direct inhalation via mouthpiece or face mask. The distance between patient and aerosol hose must be at least 10cm.						
<b>Intended users</b>	<ul style="list-style-type: none"> <li>• Medical professionals (doctor, nurse, therapist, ...)</li> <li>• Healthcare personnel or patients trained and guided by qualified medical professionals.</li> </ul> <p>User must be capable of understanding instruction manual and general device operation.</p>						
<b>Intended patients</b>	Conscious, spontaneously breathing patients.						
<b>Working environment</b>	<p>Device is intended for use in medical facility such as hospital, clinic, doctors office and in room of general household.</p> <p>It is assumed that:</p> <ul style="list-style-type: none"> <li>• nebuliser is placed on the table or trolley,</li> <li>• ambient temperature is under 30°C,</li> <li>• the distance between patient and aerosol hose is <b>at least 10 cm</b>,</li> <li>• operator is in the vicinity of the nebuliser.</li> </ul>						
<b>Lifetime</b>	<p>Lifetime of main parts of device if based on 8 hour operation with saline, at room temperature (23 °C). Lifetime may vary depending on working environment.</p> <table style="margin-left: auto; margin-right: auto;"> <tr> <td>Main unit</td> <td>5 years</td> </tr> <tr> <td>Inhalation hose</td> <td>1 year</td> </tr> <tr> <td>Bacterial filter</td> <td>50 working hours</td> </tr> </table>	Main unit	5 years	Inhalation hose	1 year	Bacterial filter	50 working hours
Main unit	5 years						
Inhalation hose	1 year						
Bacterial filter	50 working hours						
<b>Precautions for use</b>	User must read warnings and cautions described in this instruction manual.						

## Exclusions and limitations of liability



*Please remember that the warranty does not apply:*

1. to damage caused by service or maintenance performed by anyone who is not a representative of PRIZMA or a PRIZMA Authorized Distributor;
2. to damage caused by use with non-PRIZMA products and materials;
3. to damage caused by using unauthorized spare parts;
4. to damage caused by operating the product outside the permitted or intended uses described by PRIZMA in the Instruction Manual;
5. to damage caused by a poor working environment or failure to follow the written instructions, including poor or incorrect electricity and inadequate surroundings;
6. to damage caused by unauthorized modifications of the product and repairs carried out by unauthorized personnel;
7. to damage caused by Force Majeure, e.g. fire, earthquake, flood or thunder-storm.













1. Due to our commitment to the ongoing development and improvement of our products, PRIZMA reserves the right to amend or change the content of this Instruction Manual without notice.
2. The contents of this manual are believed to be correct at the time of printing. However, if you should notice any errors or omissions, please contact your local representative or PRIZMA distributor.
3. In accordance to Copyright Law, any reproduction of this Instruction Manual in whole or part is strictly prohibited without prior permission in writing by the Copyright holder.

## Safety notes

- The warning signs and the sample icons shown here are listed for you to use this product safely and correctly as well as to prevent the risk of injury.
- The icons and meanings are as follows:

Warning sign	Contents
 <b>Warning</b>	This sign indicates matters in which the possibility of death or severe bodily injury may arise as a result of incorrect handling.
 <b>Caution</b>	It indicates matters in which bodily injury or material damage* may arise as a result of incorrect handling.

\* Material damage refers to a wide range of damage involving your house, household goods, domestic animals and pets.

Examples of signs		
The  icon indicates caution (including warning and danger). Matters involving actual caution are indicated by text or pictures in or near  .	 The pictured icon refers to 'caution for flammability'.	 The pictured icon refers to 'caution for electric shock'.
The  icon indicates prohibitions (what you cannot do). Matters involving specific prohibitions are indicated by text or pictures in or near  .	 The pictured icon refers to 'prohibition to disassemble'.	 The pictured icon refers to 'general prohibition'.
The  icon indicates something that is compulsory (must be observed at any time). Matters involving specific compulsory actions are indicated by text or pictures in or near  .	 The pictured icon refers to 'general compulsion'.	 The pictured icon refers to 'unplugging the power plug'.

### Warning

Only use medications as prescribed and instructed by your doctor.

- Your physical condition may change for the worse.

When you use the unit for the first time after purchasing or after having not used it for a long time, be sure to clean and disinfect it.

- Miscellaneous types of bacteria may propagate and you may get infected.

Clean and disinfect the medication cup, medication cup cover and inhalation hose each time the unit is used.

- Miscellaneous bacteria may propagate and you may get infected. If the unit is going to be used by more than one person, prepare a disinfected medication cup, medication cup cover and inhalation hose for each person before using it. This will prevent cross-infection.

Be sure to immediately dry the cleaned and disinfected parts, and then store them in a dry place in order to prevent them from getting contaminated in the future.

In case of any problem with your nebuliser please contact your local PRIZMA service representative (address on/inside package)



## Safety notes

 **Warning**

**Do not use** this device in presence of explosive gases or in **areas with high risk of explosion.**

Use with non-flammable liquids only.

Do not use this device in combination with ventilation equipment.

Do not use in oxygen rich environment.

- The pressure in the ventilation system may reduce significantly.

When assembling the cleaned, disinfected and dried parts, do not touch the places where the medication and nebulised medication pass through directly with your hands to prevent possible infection.

Do not make any contact with the vibrator while the power plug is plugged into the electric outlet.

- You may suffer electric shock or you may injure yourself.

Do not use this device when ambient temperature is above 30°C.



Do not plug in or pull the power plug from the electric outlet with wet hands.

- You may suffer electric shock or you may injure yourself.

Do not wash the main unit with water or splash water to the power source, do not use the nebuliser while you are in bath or having a shower, never submerge the nebuliser in water.

- Short circuit may occur in the unit or you may suffer electric shock.

 **Caution**

Use only aqueous drug solutions to inhale using the nebuliser.

- If you use unsuitable solvents, it may cause failure of components and malfunction of the unit.

Clean the nebuliser with disinfectant and wash off thoroughly with water.

- If you inhale any of the remaining disinfectant, your physical condition may change for the worse.

If the nebulisation parts have already become contaminated before using the unit, clean them first before use.

- If the medication remains in the nebulisation unit, your physical condition may change for the worse.

Replace the water in the water tank each time you use the unit.

- A dirty vibrator may cause lower nebulisation rate.

Disposal of the product should be carried out in accordance with the national regulations for the disposal of electronic products.



## Safety notes

### ⚠ Caution

This equipment must only be connected to a supply mains with protective earth.

- You may suffer electric shock.

If you are not going to use the unit for a long time, be sure to unplug the power plug from the electric outlet.

Be sure to turn off the power and unplug the power plug from the electric outlet when you install or remove the device or take care of the components.

- You may suffer electric shock or you may injure yourself.



Do not look into the nebulisation section during nebulisation.

- A large amount of medication may get into your eyes and cause injury.

Do not operate the unit when the medication cup is empty.

- The unit may be overheated or damaged.

Do not fill the water tank with the liquid other than water.

- The vibrator will deteriorate and may get damaged.

When components are sterilised in an autoclave, make sure they do not directly contact the heater.

- As the temperature of the heater is very high, these components may melt or become deformed.

Do not use the power cord or the power plug if it is damaged, or do not plug the power cord into a loose electric outlet.

- You may suffer electric shock or the unit may ignite due to short circuit.

Do not scratch, tear, modify, forcibly band, pull, twist, or bundle the power cord. Do not place a heavy material on the power cord. Keep power cord away from heated or hot surfaces.

- You may suffer electric shock or the unit may ignite due to short circuit caused by the deteriorated insulation.



Do not disassemble, repair, or modify the unit in any way.

- The unit may malfunction or cause injury.

Contact your nearest PRIZMA service representative.



Do not use the power cord other than the supplied one.

- The unit may ignite or you may suffer electric shock.

Be sure to use the power source as specified on the device.

- The unit may ignite or you may suffer electric shock.

Do not share the electric outlet with other electric appliances.

- The unit may ignite or you may suffer electric shock.



To unplug the power plug from the electric outlet, do not pull the power cord; instead hold the power plug with your hand.

- The power cord may be broken or short-circuited. It may cause fire or you may suffer electric shock.



## Safety notes

### *General Advice*

Do not use the unit for any purpose other than for inhalation.

Do not use any parts other than the accessories or the optional components listed in this Instruction Manual.

Do not fill the medication cup with more than 150ml medication or less than 5ml.

Do not move the unit while medication still remains in it.

Do not block the air ventilation holes at the bottom side of the nebuliser.

Place the nebuliser on a plain and stable surface during operation.

Do not apply strong shocks to or drop the main unit.

Do not bend the inhalation hose.

- The medication may be pooled in the hose and the nebulisation rate may be lowered.

Do not inhale from the inhalation hose if the main unit is higher than your head.

- The medication may spill onto your face or clothes.

Be careful not to damage the vibrator when cleaning the water tank of the main unit.

Do not disinfect the unit by boiling in a microwave oven.

After cleaning and disinfecting the components, assemble them after they are completely dried.

Do not wipe the main unit with volatile chemicals, such as benzene or thinners.

Although the nebuliser fulfils the provisions of the EMC (Electromagnetic Compatibility) directive, the use of it should be avoided in direct vicinity of other electric devices.

Do not allow unsupervised children or infirm persons to use the unit.

## **Maintenance**

Before using the unit, be sure to confirm that the main unit operates normally and safely.

## **How to handle failures or accidents**

If an equipment error occurs, immediately take the following measures:

- 1) Power-off the unit and unplug the power plug from the electric outlet.
- 2) Write 'Faulty-Do not use' on the main unit so that it will not be used.
- 3) Contact the store where you purchased the unit or the nearest PRIZMA dealer.

## Components of the product

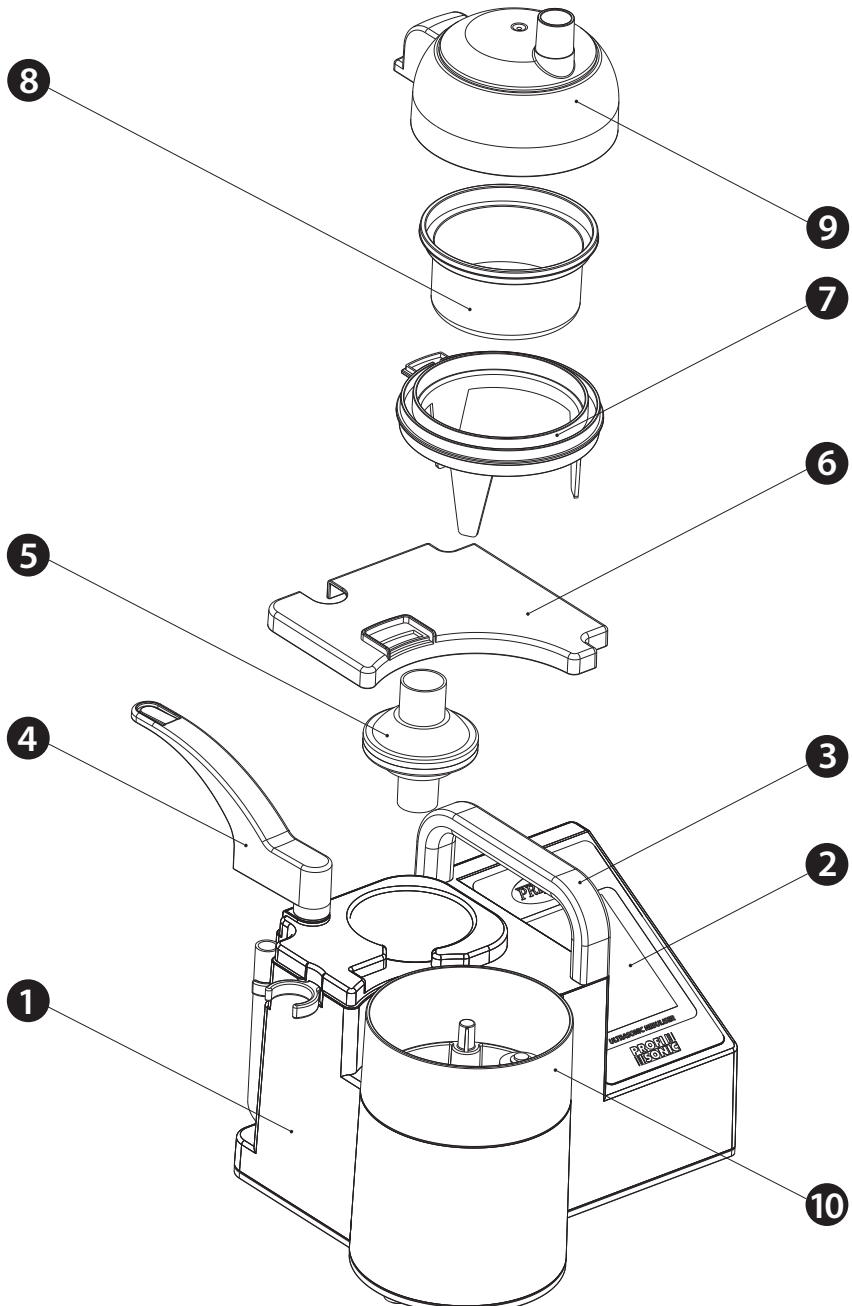

## Components of the product

- ① - Main unit
- ② - LCD touch screen display
- ③ - Handle
- ④ - Cover fixing lever
- ⑤ - Bacterial filter
- ⑥ - Filter cover
- ⑦ - Medication cup holder
- ⑧ - Medication cup
- ⑨ - Medication cup cover
- ⑩ - Water tank
- ⑪ - Power button
- ⑫ - Fuses
- ⑬ - Electric power socket
- ⑭ - Drain hose
- ⑮ - Inhalation hose holder
- ⑯ - Heater plug

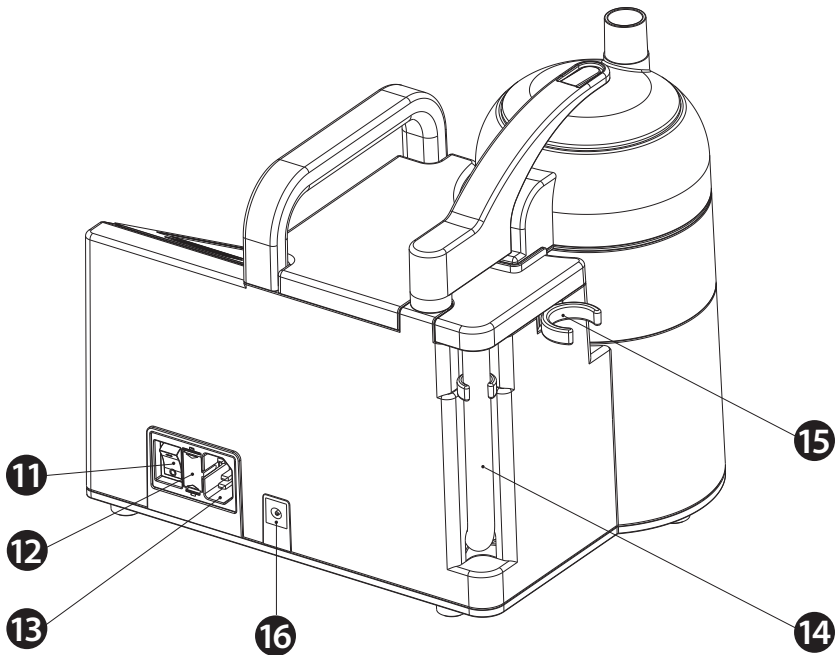

## Principle of nebulisation and main features

### Principle of nebulisation

1. PROFI SONIC H transmits the energy of ultrasonic vibrations from the vibrator located at the bottom of the water tank into water.
2. The ultrasonic vibrations are transmitted to the medication cup through the water in the water tank.
3. The ultrasonic vibrations emit medication from the medication cup (like a fountain) and it is dispersed as aerosol.
4. Air from the fan carries this nebulised medication out of the medication cup.

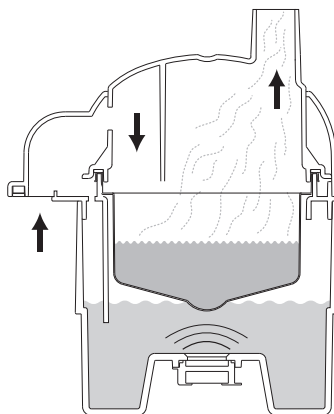

### Main features of the product

1. Easy to use large LCD displays air volume, nebulisation rate, remaining time, and error location. The back-light illumination featured in the unit enables checking of the display in the dark.
2. LCD screen is touch sensitive which enables interactive operation. The unit has a notification buzzer which produces a short sound each time a user touches a command on the screen.
3. The buzzer produces characteristic sounds when the time set by the timer is completed or when an error occurs.
4. With the use of a touch screen display, the air volume, nebulisation rate, heating level and time can be set easily and quickly. The unit can handle various inhalation therapies with the use of various optional parts.

## How to prepare before inhalation

### 1. Disassembling the nebulisation unit

Rotate the medication cup cover fixing lever **4** clockwise. Take the medication cup holder **7** (plastic ring) located below the cup cover and lift it up. In this way, the nebulisation section is removed.

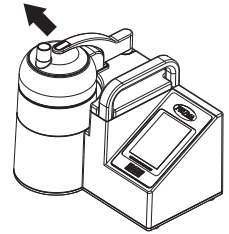

**Note:** Medication cup holder is a three-legged part which keeps it steady on the table.

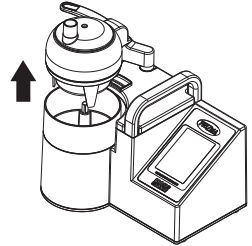

### 2. Filling the cooling water

Fill the cooling water in the water tank **10**. The proper amount is approximately 300ml. Pour some water until the sensor level float in the water tank rises to its upper position. Recommended water temperature is approximately 25°C. To prevent scale build-up in the water tank, use distilled or demineralised water instead of tap water.

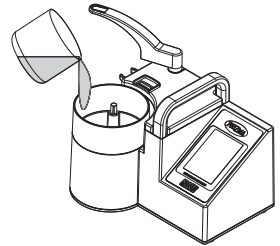

*Sensor level float in upper position*

*Water level*

*Vibrator*

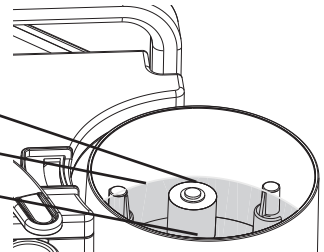

### 3. Attaching the nebulisation unit

Attach the nebulisation unit to the water tank **10**. Be sure that the air duct on the rear side of the nebulisation unit is adjusted properly to the air filter cover **6**.

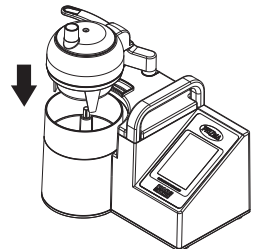

## How to prepare before inhalation

### 4. Removing the medication cup cover

Hold the medication cup holder **7** with one hand while the other is removing the medication cup cover **9**.

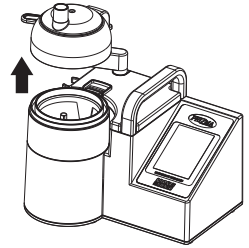

### 5. Placing the medication cup

Place the medication cup **8** in the medication cup holder (opaque plastic ring) **7**.

**Note:** The medication cup **8** is made of thin plastics. Take care not to rumple or pierce the cup.

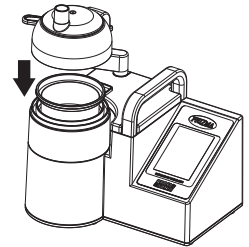

### 6. Filling medication into the medication cup

Fill medication into the medication cup **8**. Be sure the medication volume is between 5 ml and 150 ml. Use only medications prescribed by your doctor.

Maximum  
medicine level

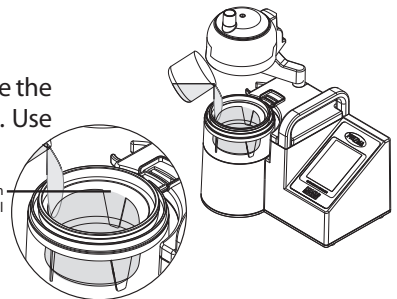

### 7. Closing the medication cup

Put the medication cup cover back **9**. Be sure to put the cover properly onto the medication cup holder. Fix the medication cup cover by rotating the cover fixing lever **4**.

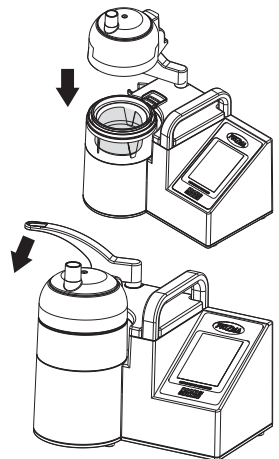

## How to prepare before inhalation

### 8. Attaching the inhalation hose

Attach the inhalation hose to the medication cup cover

⑨. Approximately 10mm of the hose length should be fitted over the adapter on the medication cup cover. Connect cable running from heating tube to socket on the rear side of unit.

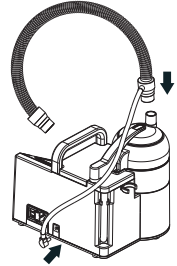

### 9. Plugging the nebuliser into the electrical outlet

Make sure that the power button ⑪ is in the OFF/0 position. If the power cord is not attached, insert it fully in the socket of the nebuliser ⑬ and plug it into an electrical outlet.

**Note:** Mains socket outlet used for connection of the control unit to the mains shall be easily reachable to the operator.

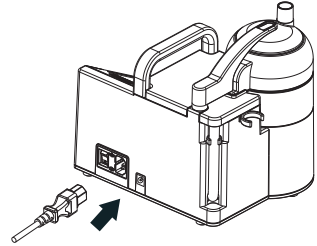

### 10. Turning the nebuliser on

Turn on the power button ⑪. The main page will appear on the screen ⑫ in a few seconds after introduction.

The initial length of inhalation time is 10 minutes as set by the manufacturer as well as the minimal values of the air-flow volume and the nebulisation rate.

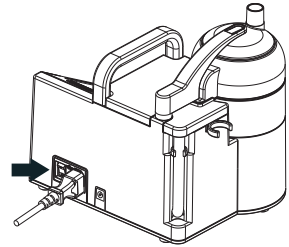

### 11. View of the LCD display

Setting the duration of inhalation (in minutes)

Setting the air-flow volume

Setting the nebulisation rate

Setting the heating level

Setting the inhalation start time

Opening the setting menu

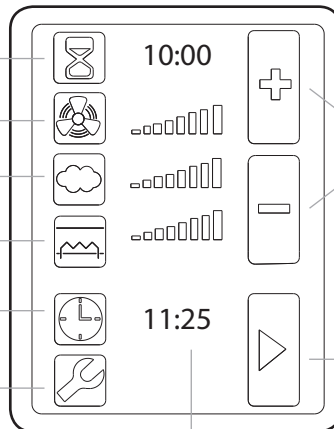

Set buttons









Inhalation START/STOP button

Current time or starting inhalation time

## How to inhale





You operate the nebuliser by pressing the icons on the touch screen. A short beep sound is produced with each command enabling the user to have greater control over the device.

**Note: Use your fingertips only to tap the LCD touch screen in order to prevent damages and to provide durability to the device. Be careful not to scratch the screen with your nails or something hard (a pencil, etc.). The time interval between two consecutive taps must be longer than 200ms, otherwise the device will not register the taps.**





<i>Icons on LCD display</i>	
Icon for setting the inhalation time. The timer is on the right side from the icon.	
Icon for setting the air-flow volume. The air-flow volume is presented in the bar graph on the right side from the icon.	
Icon for setting the nebulisation rate. The nebulisation rate is presented in the bar graph on the right side from the icon.	
Icon for setting the level of aerosol heating. The heating level is presented in the bar graph on the right side from the icon.	
If heating tube is not connected to the nebuliser, this picture will appear on display as heater button.	
Icon for setting the start of inhalation. Current daily time or start of inhalation is presented on the right side from the icon.	
Setting menu icon	
START inhalation icon	
PAUSE inhalation icon	





## How to inhale

STOP inhalation icon	
Press the "+" button to increase a parameter value.	
Press the "-" button to decrease a parameter value.	
Bar graph depicting set values of the air-flow volume and the nebulisation rate as been set.	



### 1. Setting the time



The nebuliser has a battery clock which measures time even if the nebuliser is turned off. You can set the time by pressing the button . A new page will display. Press the  button and it will change its colour into . Adjust the time by pressing the "+" and "-" buttons. If you press and hold the "+" or "-" button, time will change. Once the current time has been set, press the  button. The main page will show and the time as set will appear at the bottom of the display.

### 2. Setting the inhalation time

Press the  button. It will change its colour into . Set the inhalation time by pressing the "+" and "-" buttons. The longest possible inhalation time is 99 minutes. Once the inhalation time has been set, it will appear on the right side from the setting button.

### 3. Setting the nebulisation rate



Press the  button. It will change its colour into . Set the nebulisation rate by pressing the "+" and "-" buttons. The quantity of aerosol will appear in the eight-level bar graph on the right side from the setting button.

If the bar graph depicts the lowest aerosol quantity , and you press the "-" button again, the image  will appear instead of . It means that the nebuliser has been set to a low medication dose (less than 5ml). The inhalation time will disappear from the display, since low doses of medication are nebulised until the whole quantity has been spent. Even then the nebulisation rate may be set within eight levels.



You may leave the low dosing regime by pressing the "+" button for the highest dose of aerosol depicted in the bar graph, and then press the "+" button again.

## How to inhale





### 4. Setting the air-flow volume

Press the  button and it will change its colour into . Adjust the air-flow volume by pressing the “+” and “-” buttons. The air volume can be seen in the eight-level bar graph adjacent to the setting button.

### 5. Setting the heating level

If heating tube is connected to nebuliser, button  will appear on the screen. Press  button and it will change its colour into . Adjust heating level by pressing the “+” and “-” buttons. The heating level can be seen in the eight-level bar graph adjacent to the setting button. If heater is not connected to nebuliser, adjustment will not be possible.

### 6. Beginning the inhalation

Inhalation begins by pressing the  button. It will start if the water tank is filled with cooling water, the medication cup cover is placed and the nebuliser is not overheated. When the inhalation starts, the  button will change into , and the  button will turn into . If the nebuliser has been set to a high medication dose, the count-down time is displayed. When the set time is over, nebulisation will automatically stop along with the beeping sound.

During the nebulisation you may additionally adjust the quantity of aerosol and air-flow volume, but you may not vary the time of inhalation or the medication dose (low or high). If the water level in the water tank is low, or if the medication cup cover has not been properly placed, or if the nebuliser is overheated, the ERROR display will appear:

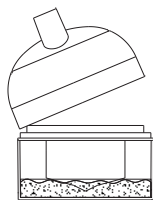

No or badly fitted medication cup cover

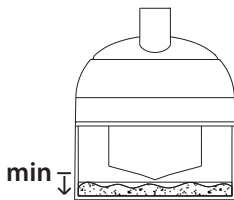

Low water level

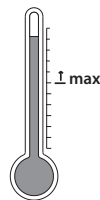



Overheated nebuliser

If the water level is low or if the medication cup cover has not been placed, fix the problem and press the  button. Then start the inhalation again.

If the nebuliser is overheated, wait for it to cool down, then press the  button and start the inhalation again.

### 7. Temporary interruption of the inhalation session

You may temporarily pause the inhalation session by pressing the  button which then change into . Converting of medication into aerosol will stop as well as the time count-down (high dose of medication only).

The inhalation session may be continued by pressing the same button again. The count-down timer will be activated again and continue to the end of session.







## How to inhale

### 8. Interruption of the inhalation before the end of session



The inhalation session may be stopped at any time by pressing the button . The main page will appear. The air-flow volume and nebulisation rate will remain on the display as set before, and the inhalation time will return to the initially set value.

### 9. Programming inhalation

You may set the nebuliser to start inhalation automatically at particular time, instead by manually pressing the button .

The unit should be prepared for inhalation (fill the cooling water in the water tank, place the medication cup, fill medication into the medication cup, assemble the medication cup cover, attach the inhalation hose). Then press the  button which will turn into . Set the inhalation time by pressing the “+” and “-” buttons. While setting, the desired inhalation time will display instead of the current time. After setting the inhalation time press the  button. The current time will reappear by the  button and the inhalation time as set before will appear below. The  button will disappear and the  button will turn into . The inhalation session will then start automatically when desired inhalation starting time is reached. From that moment on, the unit is to be handled as with manually started inhalation.

When completed or interrupted (inhalation) the inhalation time will disappear, e.g. inhalation time may be set for a single inhalation session only.

**Note:** If you need to immediately start an inhalation session, press the  button to erase the time previously set, and then press the  button. Inhalation will start immediately and the time previously set will be deleted.

**Note:** When you turn off the unit, all the values set previously will be overridden (timer settings, nebulisation rate, air-flow volume) and when you turn it on the next time all the values will reset to default as set by the manufacturer.

**Note:**

The distance between patient and aerosol hose must be at least 10cm.

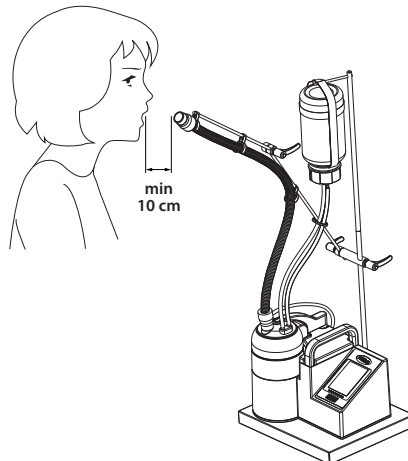

## Finishing the inhalation treatment

### When the treatment is finished you should:

1. Turn off the power button ⑪ (position 0).
2. Remove the inhalation hose from the medication cup cover.
3. Remove the medication cup cover ⑨.
4. Discard the remaining medication ⑧.
5. Discard the cooling water in the water tank ⑩. Remove the drain hose ⑭ from its holder. Put the drain hose in horizontal position (as in the picture) and allow the water to drain out into a suitable container. Wait until all the water has been drained out of the water tank and then put the drain hose back into its holder.

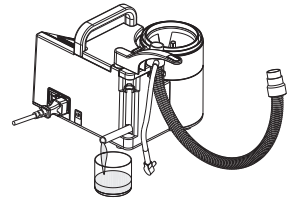
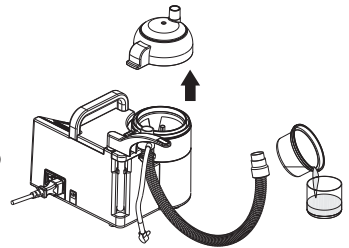

#### Notes:

- Be sure not to bend the drain hose in directions different to the one in the picture as it may become damaged.
- The volume of a suitable container should be greater than 300ml.

6. Clean and disinfect the nebuliser.

#### Warning

When assembling the cleaned, disinfected, and dried parts, do not touch the places where the medication and nebulised medication pass through directly with your hands to prevent possible infection.

Do not make any contact to the vibrator while the power plug is plugged into the electric outlet.

- You may suffer electric shock or injure yourself.



## How to take care of the nebuliser unit

### How to take care of the bacterial filter

Replace the bacterial filter after each 50 hours of operation or more often if it becomes dirty (due to the high level of dirt in the air).

To replace the filter:

1. Put the cover fixing lever **4** in back position.
2. Remove the medication cup cover **9** and medication cup holder **7**.
3. Remove the filter cover **6** by lifting its back edge first and then its left edge.
4. Take out the used filter **5**.
5. Replace it with a new one **5**.
6. Reattach the filter cover **6**.
7. Reattach the medication cup holder **7** and medication cup cover **9**.
8. Put the cover fixing lever **4** in front position.

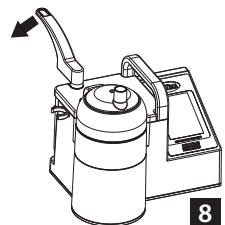
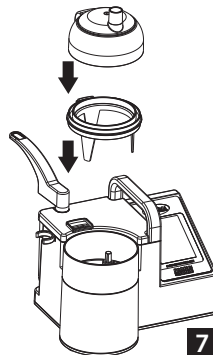
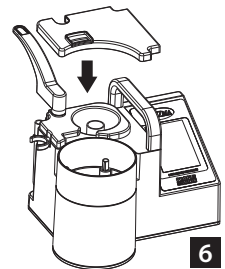
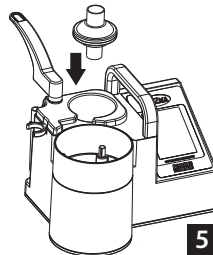
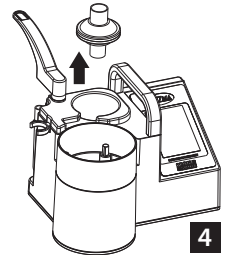
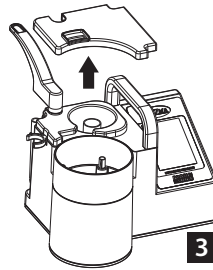
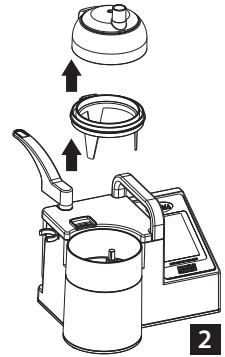
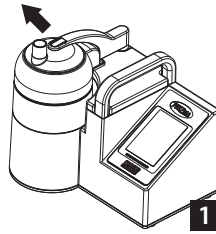

## Cleaning and disinfection

### Cleaning the unit

Clean the dust from the main unit by wiping it with a disposable cloth after being moistened with water or light-detergent solution.

Other parts of the unit may be cleaned with a light-detergent solution in warm or hot water.

#### *General advice*

- Do not wipe the main unit with volatile chemicals, such as benzene or thinners.
- Do not damage the surface of the vibrator.

### Unit disinfection procedure

All parts of the nebuliser can be disinfected with 70% ethyl-alcohol (medical grade alcohol).

Some parts of the unit may be damaged if you use disinfectants based on:

- phenols,
- alkyl amine compounds,
- halogen-releasing compounds,
- strong organic acids,
- oxygen-releasing compounds.

### Wipe disinfection

The surface of the unit and its parts are disinfected:

- by wiping the outer surface of the nebuliser unit and other parts with cotton wool slightly moistened with alcohol.
- **do not allow contact between the disinfectant and the inside of the unit.**

## Cleaning and disinfection

### Immersion disinfection

#### Do not immerse the unit in a disinfectant!

Only the medication cup holder, medication cup cover, medication cup cover sealing and inhalation hose may be immersed in a disinfectant.

The time to immerse the parts in the disinfectant differs with the type of the disinfectant used. However, 30 to 60 minutes or even longer is common.

After immersing the parts, wash them sufficiently with water and dry promptly. Carefully store the parts so that they are not re-infected.

### Boiling disinfection

#### Do not boil the main unit!

Only the medication cup cover and medication cup cover sealing can be disinfected by boiling. Boiling disinfection is performed at 93°C for 10 minutes using **detergent solution only**.

## Sterilization

#### Do not sterilize the main unit!

Only the medication cup cover and medication cup cover sealing set may be sterilized in an autoclave at 125°C.

When parts are sterilized in an autoclave, make sure these parts do not directly contact the heater inside the autoclave.

- As the temperature of the heater is very high, these parts may melt or become deformed.







## Cleaning and disinfection

### Disinfection/cleaning of the unit under home conditions

The medication cup holder, medication cup cover, medication cup and inhalation hose should be:

- washed in a warm detergent solution,
- rinsed thoroughly in running water and any excess water should be shaken from them,
- dried properly.

 <b>Warning</b>	
<p>Be sure to immediately dry the cleaned and disinfected parts, and then store them in order to prevent them from getting contaminated in the future.</p> <ul style="list-style-type: none"><li>• Miscellaneous types of bacteria may propagate and you may get infected.</li></ul>	
<p>Do not wash the main unit with water, or splash water to the power source.</p> <ul style="list-style-type: none"><li>• Electric leakage may occur in the unit or you may suffer electric shock.</li></ul>	
<p>Be sure the power cord is disconnected before cleaning, disinfection and sterilization.</p> <ul style="list-style-type: none"><li>• Electric leakage may occur in the unit or you may suffer electric shock.</li></ul>	



## Troubleshooting

<i>Trouble</i>	<i>Where to inspect</i>	<i>How to correct</i>
LCD display does not illuminate	Is the power plug securely plugged into the electric outlet?	Plug the power plug in the electric outlet correctly.
Insufficient amount of water	Is the water in the water tank up to the level float?	Fill the water up to the level float.
No medication cup cover	Is the medication cup cover correctly set to the main unit?	Set the medication cup cover by attaching it to the medication cup holder and rotate the cover fixing lever to front position.
After the inhalation starts the unit is overheated.	Are the air vents at the bottom blocked?	Unblock the air vents at the bottom of the unit. Wait for the unit to cool down.
The unit does not nebulise.	Is the medication cup correctly set?	Set the medication cup correctly.
	Is the amount of medication in the medication cup too much?	Reduce the amount of medication to less than 150ml.
	Is the inhalation hose bent and the medication pooled in the hose?	Adjust the bent hose correctly and drain the pooled medication.
Insufficient amount of aerosol.	Is the amount of medication in the medication cup too small?	Increase the amount of medication to more than 5 ml.
The amount of aerosol has decreased.	Is the amount of medication in the medication cup too much?	Reduce the amount of medication to less than 150 ml.
	Is the value of nebulisation rate set too low?	Adjust the value of nebulisation rate by pressing the "+" button.
	Is the room temperature too low and/or water temperature too low?	Start the inhalation without medication for about 4 minutes, and then use the unit.
	Is the medication cup clean?	After cleaning the medication cup with the detergent, wash off the detergent sufficiently under running water before using the cup.
	Is the bacterial filter blocked?	Replace the bacterial filter with a new one.
Nebulisation is unstable.	Is the amount of medication exceeding 150 ml?	Reduce the amount of medication to less than 150 ml.
	Are the air volume and the nebulisation rate set to the maximum level when the amount of medication is 150 ml?	Adjust the air volume and nebulisation rate.
The unit does not heat aerosol.	Is the heating level set high enough?	Increase heating level.
	Check electrical connection between heating hose and nebuliser.	Insert connector at the end of heating hose cable to the plug located on the rear side of nebuliser.

- If the unit does not operate normally after taking the above-mentioned measures, do not touch the internal mechanism and consult the store where you purchased the unit or the nearest PRIZMA service centre.

## Specifications

### Technical data

This device fulfils the provisions of the EC directive 93/42/EEC (Medical Device Directive).

<b>Product name</b>	PRIZMA Ultrasonic Nebuliser
<b>Model</b>	PROFI SONIC H
<b>Product class</b>	Ila
<b>Power source</b>	100-240V~, 50-60Hz
<b>Power consumption</b>	90VA
<b>Fuse</b>	2 x T2AH/250VAC
<b>Electrical safety</b>	I
<b>Electromagnetic emissions</b>	In accordance with EN 60601-1-2 standard
<b>Noise level</b>	<35dBA
<b>Ultrasonic frequency</b>	1.7MHz
<b>Nebulisation rate*</b>	0-5 ml/min, adjustable
<b>Particle size</b>	0.5-5 µm
<b>Air volume</b>	Maximum 20 l/min, adjustable
<b>Amount of cooling water</b>	300 ml
<b>Capacity of medication cup</b>	150 ml (min. 5 ml)
<b>Clock battery</b>	CR2032, 3V
<b>External dimensions</b>	260 x 250 x 200
<b>Weight of the main unit</b>	1.8kg
<b>Operating conditions</b>	15 - 30°C (59 - 86°F), 30 - 85% RH, 700-1060 hPa
<b>Transport/storage conditions</b>	0 - 45°C (32 - 113°F), 30 - 85% RH, 700-1060 hPa
<b>Package contents</b>	Main unit, inhalation hose (75 cm), 3 medication cups (one already installed), 1 bacterial filter (already installed), power cord, Instruction Manual (with warranty card)

\* May change depending on the type of medication

- Specifications and appearance is subject to change without prior notice.

Symbols:



= Read the instruction manual carefully



= Correct disposal of this product (Waste electrical & electronic equipment)

Manufacturer:  
PRIZMA D.O.O.  
Kumanovska 8  
34000 Kragujevac, Serbia



CE 1304

Representative in EU:  
GRAJSKA VRATA d.o.o.  
Šmiklavž 3a  
3342 Gornji Grad, Slovenia

EC

REP

### ***Important information regarding Electro Magnetic Compatibility (EMC)***

With the increased number of electronic devices such as PC's and mobile (cellular) telephones, medical devices in use may be susceptible to electromagnetic interference from other devices. Electromagnetic interference may result in incorrect operation of the medical device and create a potentially unsafe situation.

Medical device should also not interfere with other devices.

In order to regulate the requirements for EMC (Electro Magnetic Compatibility) with the aim to prevent unsafe product situations, the EN60601-1-2 standard has been implemented. This standard defines the levels of immunity to electromagnetic interferences as well as maximum levels of electromagnetic emissions for medical devices.

This medical device manufactured by PRIZMA conforms to this EN60601-1-2:2007 standard for both immunity and emissions.

Nevertheless, special precautions need to be observed:

- Do not use mobile (cellular) telephones and other devices which generate strong electrical or electromagnetic fields near medical device. This may result in incorrect operation of the unit and create potentially unsafe situation. Recommendation is to keep a minimum distance of 7 m. Verify correct operation of device in case the distance is shorter.

Further documentation in accordance with EN60601-1-2:2007 is available at PRIZMA at address mentioned in this instruction manual.

Documentation is also available at [www.prizma.rs](http://www.prizma.rs).



### ***Correct disposal of this product (Waste electrical & electronic equipment)***

This marking shown on the product or its literature indicates that it should not be disposed of with other household wastes at the end of its working life. To prevent possible harm to environment or human health from uncontrolled waste disposal, please separate this from other types of wastes and recycle it responsibly, to promote sustainable reuse of material resources.

Household users should contact either the retailer where they purchased this product or their local government office for details of where and how they can take this item for environmentally safe recycling.

Business user should contact their supplier and check the terms and conditions of purchase contract. This product should not be mixed with other commercial wastes for disposal.

This product does not contain any hazardous substances.

## Optional parts

### Inhalation hose with heater

Catalogue Code: PSIH H

Material: Hitrel

Packaging unit: 1 pc

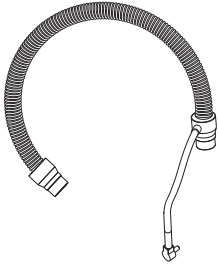

### Bacterial filter

Catalogue Code: PSBF

Packaging unit: 1 pc

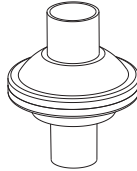

### Medication cup

Catalogue Code: PSMC

Material: PET

Packaging unit: 5 pcs



### Medication supply set

Catalogue Code: PSMS

Material: PP

Packaging unit: 1 set



### Desktop stand

Catalogue Code: PSDS

Packaging unit: 1 set

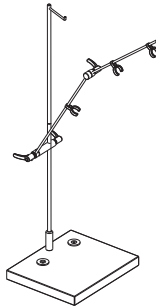

### Trolley stand

Catalogue Code: PSTS

Packaging unit: 1 set

